

SU20 SERIES
20 Watts
KEY FEATURES

- Power Module for PCB Mountable
- 2:1 & 4:1 Wide Input Range
- Regulated Output
- Low Ripple and Noise
- Screw Terminal For Optional
- Vout Trim and ON/OFF Control Function
- 3-Years Product Warranty

ELECTRICAL SPECIFICATIONS

Model No. (Single Output)	SU20-12-3.3S	SU20-12-5S	SU20-12-12S	SU20-12-15S	SU20-12-24S
Input Voltage (V.DC.)	12V (9-18V)	12V (9-18V)	12V (9-18V)	12V (9-18V)	12V (9-18V)
Efficiency	76%	78%	81%	82%	83%
capacitor Load max	28000μF	10000μF	2000μF	755μF	330μF

Model No. (Single Output)	SU20-24-3.3S	SU20-24-5S	SU20-24-12S	SU20-24-15S	SU20-24-24S
Input Voltage (V.DC.)	24V (18-36V)	24V (18-36V)	24V (18-36V)	24V (18-36V)	24V (18-36V)
Efficiency	78%	81%	86%	85%	88%
capacitor Load max	28000μF	10000μF	2000μF	755μF	330μF

Model No. (Single Output)	SU20-24F-3.3S	SU20-24F-5S	SU20-24F-12S	SU20-24F-15S	SU20-24F-24S
Input Voltage (V.DC.)	24V (10-40V)	24V (10-40V)	24V (10-40V)	24V (10-40V)	24V (10-40V)
Efficiency	82%	84%	82%	82%	82%
capacitor Load max	18000μF	960μF	750μF	370μF	160μF

Model No. (Single Output)	SU20-48-3.3S	SU20-48-5S	SU20-48-12S	SU20-48-15S	SU20-48-24S
Input Voltage (V.DC.)	48V (36-75V)	48V (36-75V)	48V (36-75V)	48V (36-75V)	48V (36-75V)
Efficiency	76%	82%	84%	85%	87%
capacitor Load max	28000μF	10000μF	2000μF	755μF	330μF

Model No. (Single Output)	SU20-48F-3.3S	SU20-48F-5S	SU20-48F-12S	SU20-48F-15S	SU20-48F-24S
Input Voltage (V.DC.)	48V (18-75V)	48V (18-75V)	48V (18-75V)	48V (18-75V)	48V (18-75V)
Efficiency	83%	85%	82%	82%	82%
capacitor Load max	18000μF	960μF	750μF	370μF	160μF

Model No. (Dual · Triple Output)	SU20-12-5D	SU20-12-12D	SU20-12-15D	SU20-12-5S12D	SU20-12-5S15D
Input Voltage (V.DC.)	12V (9-18V)	12V (9-18V)	12V (9-18V)	12V (9-18V)	12V (9-18V)
Efficiency	77%	81%	82%	79%	77%
capacitor Load max	±3000μF	±680μF	±330μF	6000/ ±150μF	4000/ ±150μF

Model No. (Dual · Triple Output)	SU20-24-5D	SU20-24-12D	SU20-24-15D	SU20-24-5S12D	SU20-24-5S15D
Input Voltage (V.DC.)	24V (18-36V)	24V (18-36V)	24V (18-36V)	24V (18-36V)	24V (18-36V)
Efficiency	82%	84%	85%	83%	81%
capacitor Load max	±3000μF	±680μF	±330μF	6000/ ±150μF	4000/ ±150μF

Model No. (Dual · Triple Output)	SU20-24F-5D	SU20-24F-12D	SU20-24F-15D
Input Voltage (V.DC.)	24V (10-40V)	24V (10-40V)	24V (10-40V)
Efficiency	81%	82%	82%
capacitor Load max	±4800μF	±370μF	±270μF

Model No. (Dual · Triple Output)	SU20-48-5D	SU20-48-12D	SU20-48-15D	SU20-48-5S12D	SU20-48-5S15D
Input Voltage (V.DC.)	48V (36-75V)	48V (36-75V)	48V (36-75V)	48V (36-75V)	48V (36-75V)
Efficiency	83%	85%	84%	83%	84%
capacitor Load max	±3000μF	±680μF	±330μF	6000/ ±150μF	4000/ ±150μF

Model No. (Dual · Triple Output)	SU20-48F-5D	SU20-48F-12D	SU20-48F-15D
Input Voltage (V.DC.)	48V (18-75V)	48V (18-75V)	48V (18-75V)
Efficiency	81%	83%	82%
capacitor Load max	±4800μF	±370μF	±270μF

SU20 SERIES
20 Watts

Model No. (Single Output)	SU20-12-3.3S SU20-24-3.3S SU20-24F-3.3S SU20-48-3.3S SU20-48F-3.3S	SU20-12-5S SU20-24-5S SU20-24F-5S SU20-48-5S SU20-48F-5S	SU20-12-12S SU20-24-12S SU20-24F-12S SU20-48-12S SU20-48F-12S	SU20-12-15S SU20-24-15S SU20-24F-15S SU20-48-15S SU20-48F-15S	SU20-12-24S SU20-24-24S SU20-24F-24S SU20-48-24S SU20-48F-24S	
Max Output Wattage (W)	13.2W	20W	20W	20W	20W	
Input	Input Filter	π type				
Output	Voltage (V.DC.)	3.3	5	12	15	24
	Voltage Accuracy	$\pm 2\%$				
	Current (mA) max	4000	4000	1670	1330	833
	Line Regulation (LL-HL) (typ.)	$\pm 0.5\%$				
	Load Regulation (10-100%) (typ.)	$\pm 0.5\%$				
	Ripple	$< 0.2\% V_{out} + 20mV$ max (Vp-p)				
	Noise	$< 0.5\% V_{out} + 50mV$ max (Vp-p)				
	Trim	$\pm 10\%$				
Protection	Switching Frequency	2:1 Range :200KHz		4:1 Range :250KHz		
	Over Power Protection	Works over 120% of rating and recovers automatically.				
	Over Voltage Protection	Zener diode clamp				
Isolation	Short Circuit Protection	Hiccup, auto-recovery				
	Voltage	1600 VDC.				
	Resistance	10^8 ohms				
Environment	Capacitance	1000 pF				
	Operating Temperature	2:1 Range: $-25^{\circ}C \dots +70^{\circ}C$ (at Full Load)		4:1 Range: $-25^{\circ}C \dots +70^{\circ}C$ (with derating)		
	Storage Temperature	$-55^{\circ}C \dots +105^{\circ}C$				
	Case Temperature	$+100^{\circ}C$ max.				
	Temperature Coefficient	$\pm 0.02\%$ Per $^{\circ}C$				
	Humidity	95% RH				
Physical	MTBF	$> 550,000$ h @ $25^{\circ}C$ (MIL-HDBK-217F)				
	Dimension (L x W x H)	2.0 x 2.0 x 0.45 Inches (50.8 x 50.8 x 11.4 mm) Tolerance ± 0.5 mm				
	Case Material	Five-side shielded Aluminum with Non-Conductive base, Black Anodize				
	Weight	70 g				
Safety	Agency Approvals	CE (Pending)				
EMC	EMI (Conducted & Radiated Emission)	EN 55022 class A				

 1.All specifications valid at normal input voltage, full load and $+25^{\circ}C$ after warm-up time unless otherwise stated.

2.Ripple & Noise are measured at 20MHz of bandwidth with 0.1UF & 47UF parallel capacitor.

Model No. (Dual · Triple Output)	SU20-12-5D SU20-24-5D SU20-24F-5D SU20-48-5D SU20-48F-5D	SU20-12-12D SU20-24-12D SU20-24F-12D SU20-48-12D SU20-48F-12D	SU20-12-15D SU20-24-15D SU20-24F-15D SU20-48-15D SU20-48F-15D	SU20-12-5S12D SU20-24-5S12D SU20-48-5S12D	SU20-12-5S15D SU20-24-5S15D SU20-48-5S15D	
Max Output Wattage (W)	20W	20W	20W	20W	20W	
Input	Input Filter	π type				
Output	Voltage (V.DC.)	± 5	± 12	± 15	5/ ± 12	5/ ± 15
	Voltage Accuracy	$\pm 2\%$				
	Current (mA) max	± 2000	± 833	± 660	2500 / ± 300	2500 / ± 250
	Line Regulation (LL-HL) (typ.)	$\pm 0.5\%$				
	Load Regulation (10-100%) (typ.)	$\pm 3\%$				
	Ripple	$< 0.2\% V_{out} + 20mV$ max (Vp-p)				
	Noise	$< 0.5\% V_{out} + 50mV$ max (Vp-p)				
	Trim	$\pm 10\%$				None
Protection	Switching Frequency	2:1 Range :200KHz		4:1 Range :250KHz		
	Over Power Protection	Works over 120% of rating and recovers automatically.				
	Over Voltage Protection	Zener diode clamp				
Isolation	Short Circuit Protection	Hiccup, auto-recovery				
	Voltage	1600 VDC.				
	Resistance	10^8 ohms				
Environment	Capacitance	1000 pF				
	Operating Temperature	2:1 Range: $-25^{\circ}C \dots +70^{\circ}C$ (at Full Load)		4:1 Range: $-25^{\circ}C \dots +70^{\circ}C$ (with derating)		
	Storage Temperature	$-55^{\circ}C \dots +105^{\circ}C$				
	Case Temperature	$+100^{\circ}C$ max.				
	Temperature Coefficient	$\pm 0.02\%$ Per $^{\circ}C$				
	Humidity	95% RH				
Physical	MTBF	$> 550,000$ h @ $25^{\circ}C$ (MIL-HDBK-217E)				
	Dimension (L x W x H)	2.0 x 2.0 x 0.45 Inches (50.8 x 50.8 x 11.4 mm) Tolerance ± 0.5 mm				
	Case Material	Five-side shielded Aluminum with Non-Conductive base, Black Anodize				
	Weight	70 g				
Safety	Agency Approvals	CE (Pending)				
EMC	EMI (Conducted & Radiated Emission)	EN 55022 class A				

 1.All specifications valid at normal input voltage, full load and $+25^{\circ}C$ after warm-up time unless otherwise stated.

2.Ripple & Noise are measured at 20MHz of bandwidth with 0.1UF & 47UF parallel capacitor.

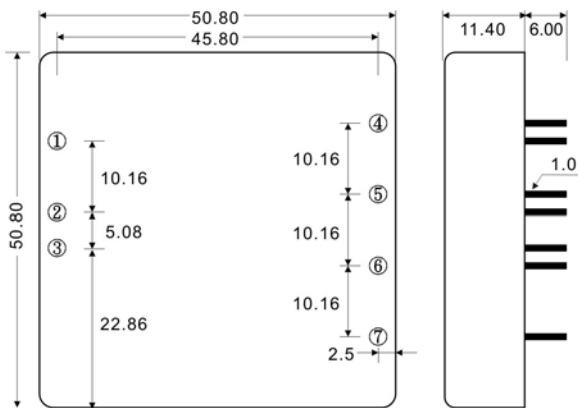
MECHANICAL DIMENSION (Top View)

PIN#	Single	Dual	Triple
1	ON / OFF	ON / OFF	ON / OFF
2	-VIN	-VIN	-VIN
3	+VIN	+VIN	+VIN
4	TRIM	TRIM	-VOUT
5	-VOUT	-VOUT	COMMON
6	+VOUT	COMMON	+5V OUT
7	NC	+VOUT	+VOUT

OUTPUT NOISE

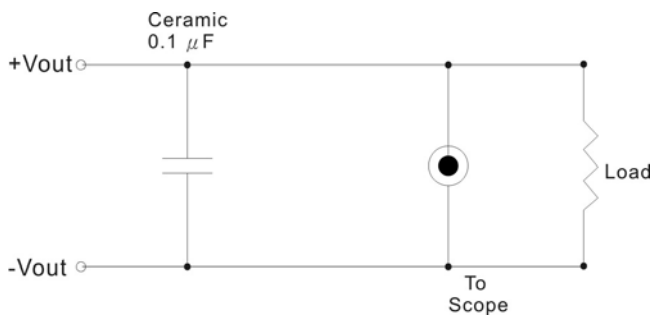
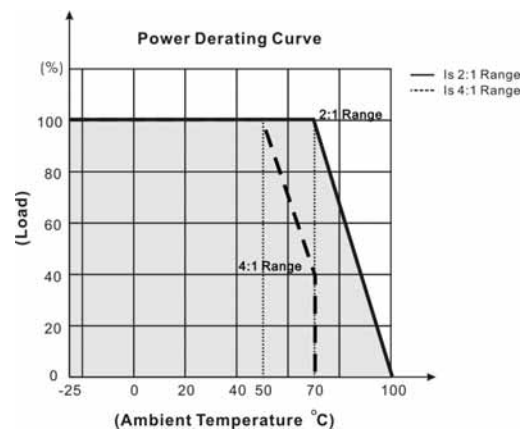
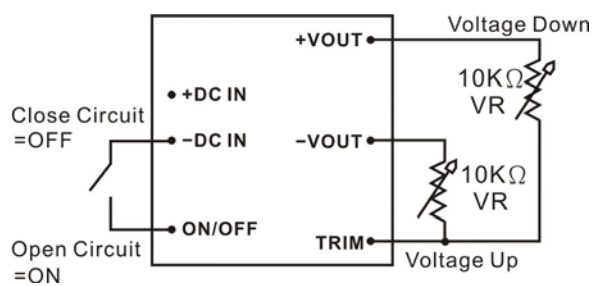
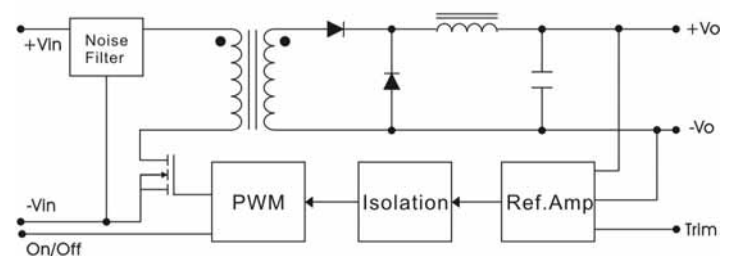
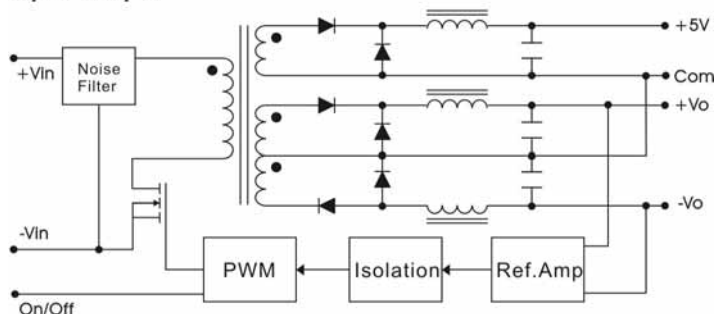
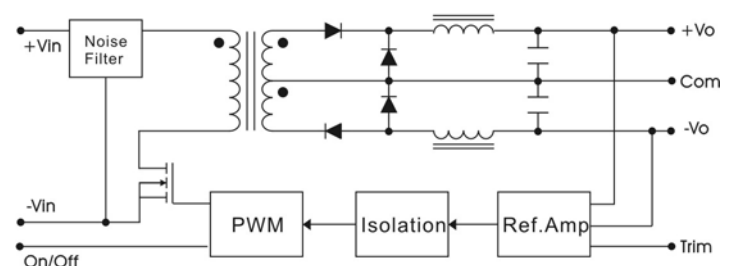
 The output noise is measured with 0.1 μ F tantalum capacitor.

DERATING

REMOTE ON/OFF CONTROL & TRIM

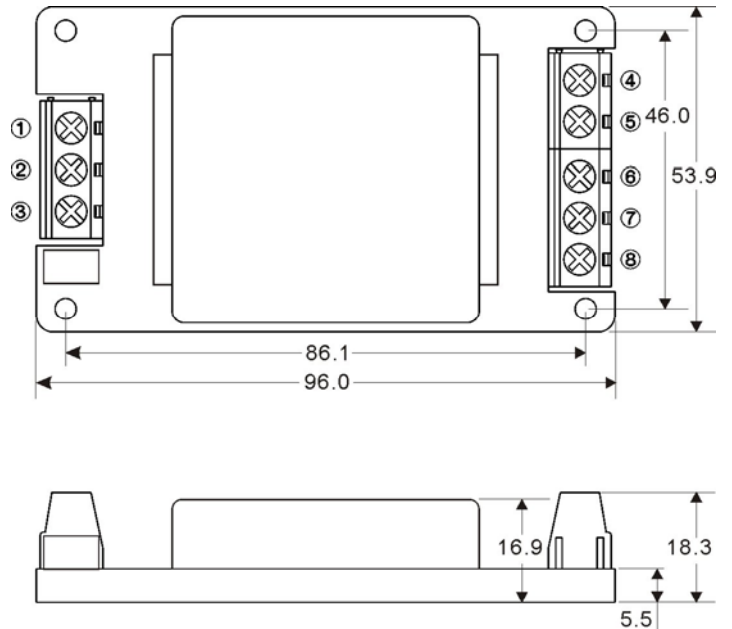
BLOCK DIAGRAM
Single Output

Triple Output

Dual Output

SU20 SERIES
20 Watts
SCREW TERMINAL
SU20-A2

PIN#	Single	Dual	Triple
1	CTRL	CTRL	CTRL
2	-DC IN	-DC IN	-DC IN
3	+DC IN	+DC IN	+DC IN
4.	TRIM	TRIM	-DC OUT
5	-DC OUT	-DC OUT	COMMON
6	NO CONNECT	NO CONNECT	NO CONNECT
7	+DC OUT	COMMON	+5V OUT
8	NO CONNECT	+DC OUT	+DC OUT

SU20-A5

PIN#	Single	Dual	Triple
1	CTRL	CTRL	CTRL
2	-DC IN	-DC IN	-DC IN
3	+DC IN	+DC IN	+DC IN
4.	TRIM	TRIM	-DC OUT
5	-DC OUT	-DC OUT	COMMON
6	NO CONNECT	NO CONNECT	NO CONNECT
7	+DC OUT	COMMON	+5V OUT
8	NO CONNECT	+DC OUT	+DC OUT

